

RoHS Compliant

B TO B CONN., PITCH: 0.5mm, MALE, H=3.55mm,
SMT TYPE

MATERIAL:

HOUSING: SEE ORDER INFORMATION (UL94V-0)
HOUSING COLOR: SEE ORDER INFORMATION
TERMINAL: PHOSPHOR BRONZE
TERMINAL PLATING: FULL Au OVER 50u" min. Ni
UNDERPLATE OVERALL
GROUNDING PIN: BRASS
GROUNDING PIN PLATING: Sn PLATED
PACKING: SEE ORDER INFORMATION

ORDER INFORMATION

G2850-15 ** ** * * -00

① ② ③ ④

① PIN NUMBER:

- △ 10: 2*10PIN
- 15: 2*15PIN
- 20: 2*20PIN
- 30: 2*30PIN
- 40: 2*40PIN

② HOUSING MATERIAL&COLOR:

- 00: LCP, BLACK
- 01: LCP, NATURE

③ PACKING:

- 0: REEL

④ TERMINAL PLATING:

- 1: GOLD FLASH
- 2: 3u" Au

REV	DATE	DESCRIPTION	ECN NO.	NAME
A	12.10.16	PROPOSAL		LFW
A1	14.12.11	△ MODIFY		LRP
A2	15.10.08	△ MODIFY		Huhao

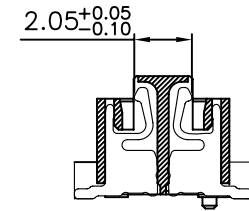
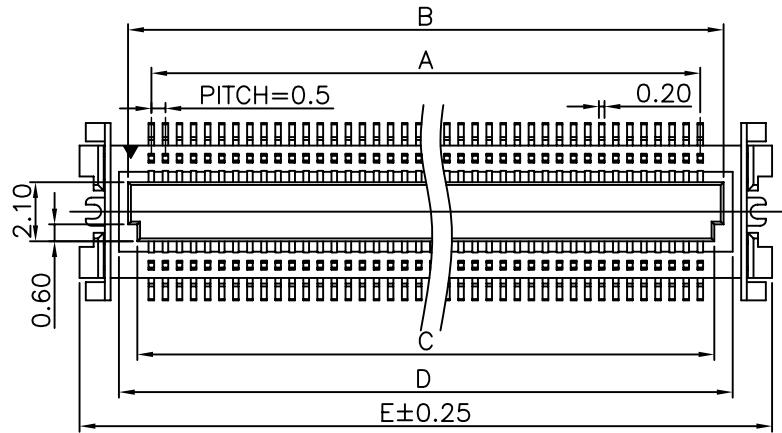

SECTION A-A

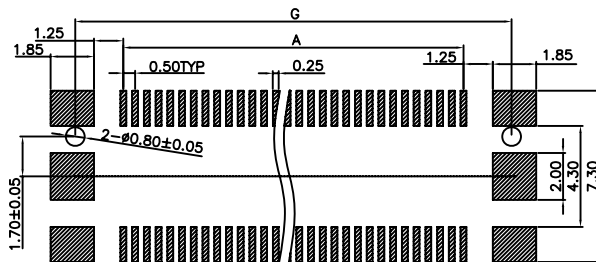
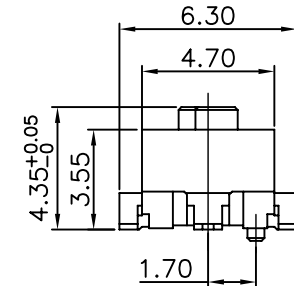
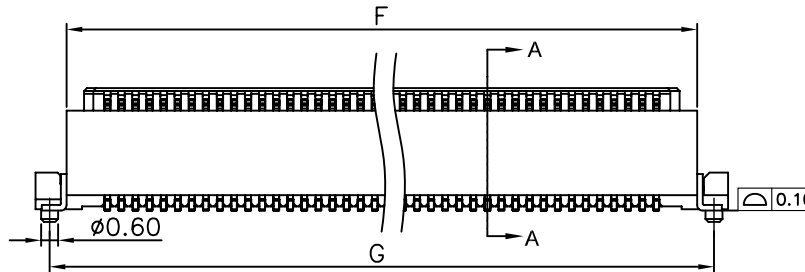

RECOMMENDED P.C.BOARD HOLE LAYOUT

DIM:

- A=(No. of contacts/2-1)*0.5
- B=A+1.65
- C=A+1.0
- D=A+2.3
- F=A+5.1
- G=A+2.9
- G=A+4.1

NOTE: 1. P.C.B LAYOUT TOLERANCE: ±0.05mm
2. SMT COPLANARITY TOLERANCE Max: 0.10mm
3. GENERAL TOLERANCE: ±0.20

GENERAL TOLERANCE ±0.25mm GENERAL ANGLE TOLERANCE ±3° 	WIESON TECHNOLOGIES CO., LTD	PART NO.: G2850-15*****-00	
	DRAWN BY LFW(WSC)	DRAWING NO.	G2850-15*****-00
	CHECKED BY JINKENS	DRAWING SIZE	A4
	APPROVED BY JINKENS	UNIT	mm
	SORTING NO. CA0015(WSC)	PAGE	1 OF 2

PROPOSAL

[ARTICLE:044033 V6]

RoHS Compliant

B TO B CONN., PITCH: 0.5mm, MALE, H=3.55mm, SMT TYPE

REV	DATE	DESCRIPTION	ECN NO.	NAME
A	12.10.16	PROPOSAL		LFW
A1	14.12.11	△ MODIFY		LRP
A2	15.10.08	△ MODIFY		Huhao

A

B

C

D

E

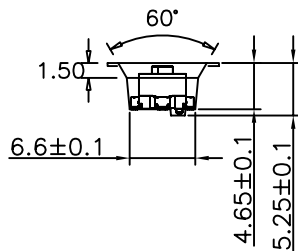
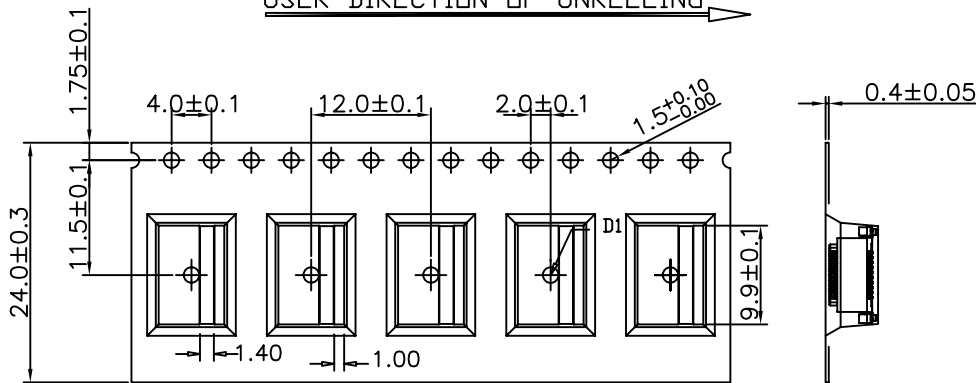
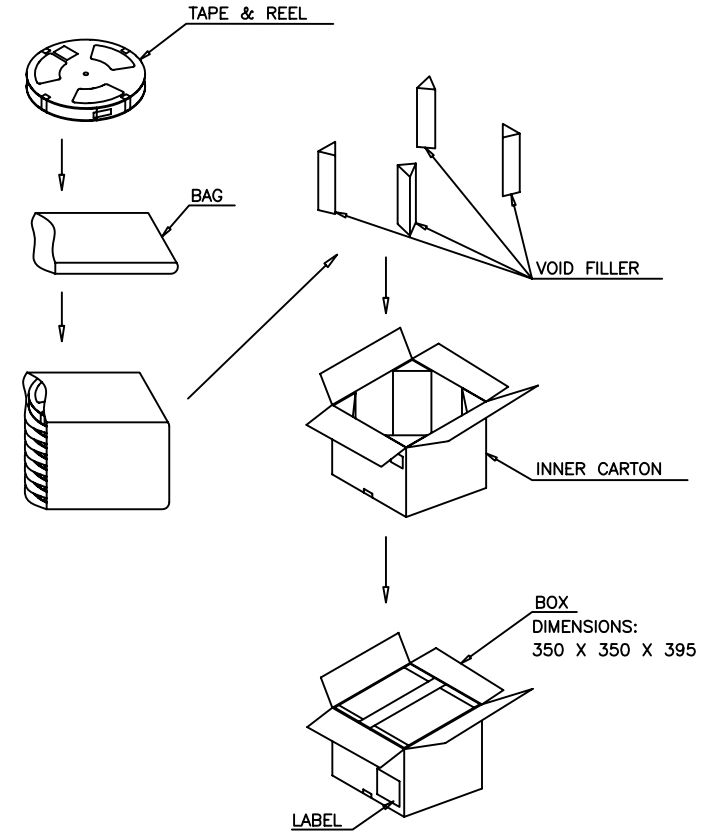
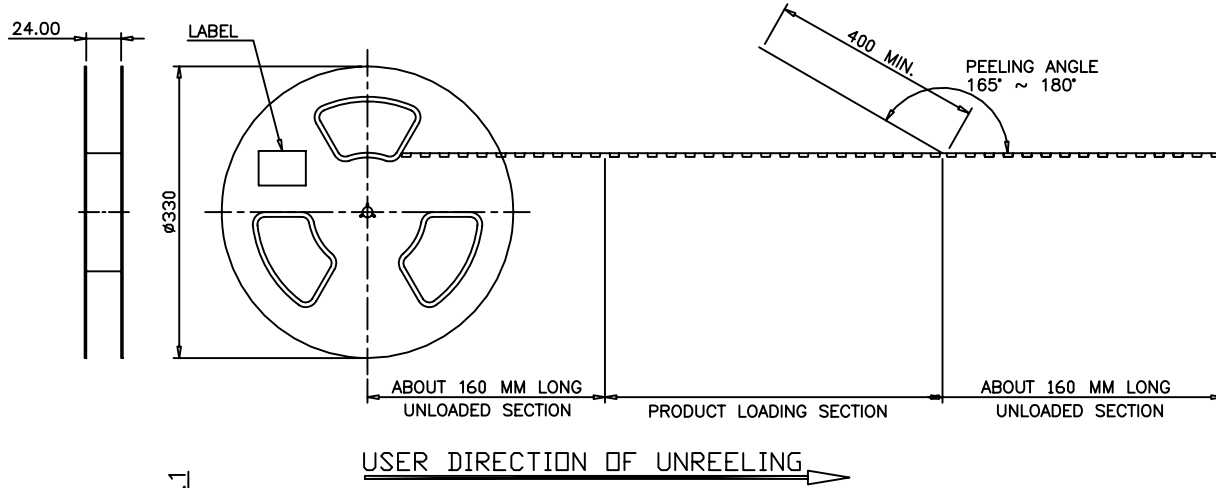

NOTE: 1. 1000PCS/REEL;11REEL/CARTON.
2. ONLY FOR G2850-15100101-00.

— GENERAL TOLERANCE — ± 0.25mm	WIESON TECHNOLOGIES CO., LTD		PART NO.: G2850-15*****-00	
	DRAWN BY	LFW(WSC)	DRAWING NO.	G2850-15*****-00
GENERAL ANGLE TOLERANCE ± 3°	CHECKED BY	JINKENS	DRAWING SIZE	A4
	APPROVED BY	JINKENS	UNIT	mm
⊕	SORTING NO.	CA0015(WSC)	PAGE	2 OF 2

PROPOSAL

[ARTICLE:044033 V6]

RoHS Compliant

B TO B CONN., PITCH: 0.5mm, FEMALE, H=3.4mm, SMT TYPE

REV	DATE	DESCRIPTION	ECN NO.	NAME
A	12.10.16	PROPOSAL		LFW

MATERIAL:
 HOUSING: SEE ORDER INFORMATION (UL94V-0)
 HOUSING COLOR: SEE ORDER INFORMATION
 TERMINAL: BRASS
 TERMINAL PLATING: FULL Au OVER 50u" min. Ni UNDERPLATE OVERALL
 GROUNDING PIN: BRASS
 GROUNDING PIN PLATING: Sn PLATED
 PACKING: SEE ORDER INFORMATION

ORDER INFORMATION
 G4296-16 ** ** * * -00

- ① PIN NUMBER:
 10: 2*10PIN
 11: 2*11PIN
 ..
 15: 2*15PIN
- ② HOUSING MATERIAL&COLOR:
 00: LCP, BLACK
 01: LCP, NATURE
- ③ PACKING:
 0: REEL
- ④ TERMINAL PLATING:
 1: GOLD FLASH
 2: 3u" Au

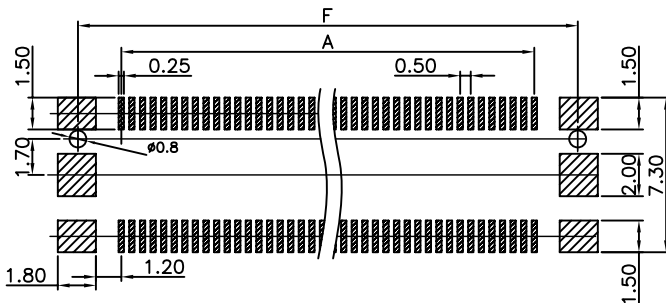
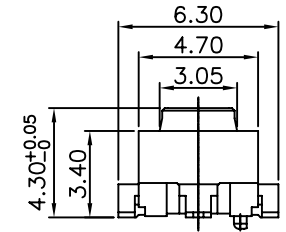
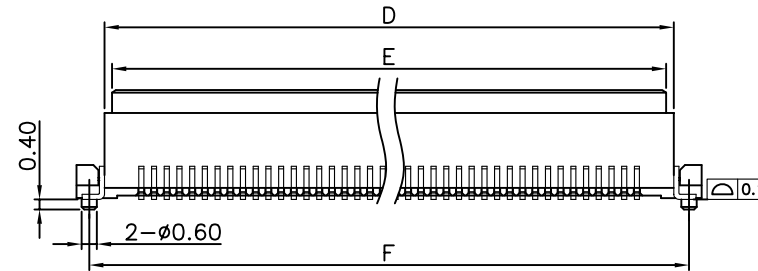
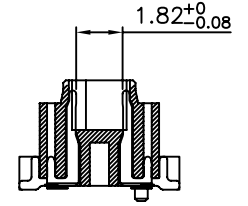
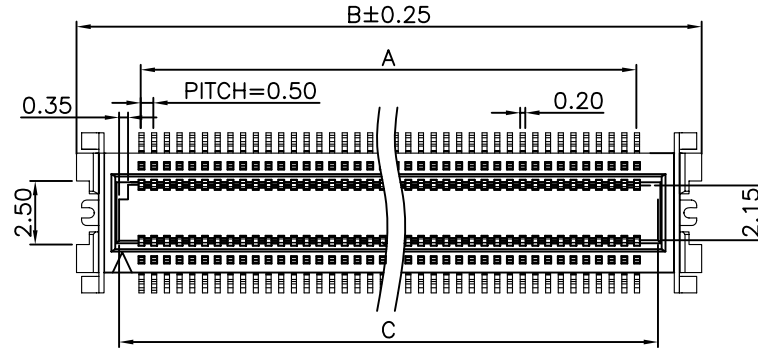

RECOMMENDED P.C. BOARD HOLE LAYOUT

NOTE: 1. P.C.B LAYOUT TOLERANCE: ±0.05mm
 2. SMT COPLANARITY TOLERANCE Max: 0.10mm
 3. GENERAL TOLERANCE: ±0.20

DIM:
 A=(No. of Contacts/2-1)*0.5
 B=A+5.1
 C=A+1.7
 D=A+2.9
 E=A+2.3
 F=A+4.1

GENERAL TOLERANCE ±0.25mm GENERAL ANGLE TOLERANCE ±3° 	WIESON TECHNOLOGIES CO., LTD	PART NO.: G4296-16*****-00	
	DRAWN BY LFW(WSC)	DRAWING NO.	G4296-16*****-00
	CHECKED BY JINKENS	DRAWING SIZE	A4
	APPROVED BY JINKENS	UNIT	mm
	SORTING NO. CA0015(WSC)	PAGE	1 OF 1

PROPOSAL

[ARTICLE:044033 V6]